

Basic Elements of SMT Pick and Place Machine

Several core elements you must know for purchasing machines

The Most Essential Elements of A **Qualified** Pick and Place Machine

Before purchasing a machine, we must carry out a reasonable appraisal and consideration of the most essential performance. The quality and price varies vastly due to the multiple brands,so customers can't even figure out how to choose one which is most suitable for himself. And it is very necessary for you to make full preparation before purchasing.

Then how can we choose a machine suitable for ourselves?

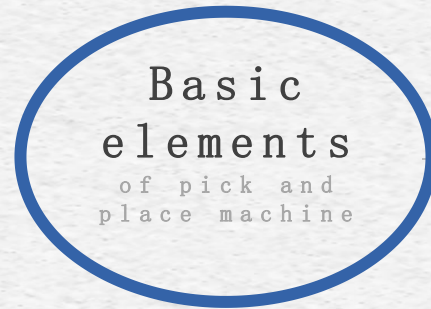

The resistor and capacitor above 0402 can not represent the accuracy of the machine. The mounting accuracy and repeated mounting accuracy referred mean whether the precision chip with the lead pitch of 0.3mm can be accurately mounted. And the process can be completed without a second adjustment in a row for ten times.



After adjusting the program, the rate of finished products is higher than 99.5% under the condition of continuous 24-hour mounting.



The degree of manual involvement in the process of programming is less than 15%, most of the work is undertaken by the software part of the machine and completed automatically.



It refers to the mounting efficiency of the equipment per hour,namely the number of components to mount in unit time under the premise of ensuring the stability,for example, with stopwatch timing, the mounting efficiency of the machine is $100 / 25 * 3600 = 14400$ pc/h based on the calculation of 25 seconds for 100 pieces.

* In accordance with International standards

Introduction of Accuracy Unit

0.05mm

Mounting Accuracy

0.01mm

Positioning Accuracy

0.02mm

Repeated Accuracy

24h

Non-stop Work



HW-T4-50F/44FX

Independent high-speed multi-function machine with four heads which can hold 50/44 feeders





The Real Shot from the
Front



Desk Machine



The Real Shot from the
Front



Vertical Machine



External

Structure

of the Machine



Warning Light

防护罩

Housing

HW-T4-50F

Emergency stop knob
Power switch

Keyboard & Mouse

Width Adjustable Tracks

Feeder Slots

USB interfaces
Computer switch

Electric Control Box

Heavy Load Anchor with Reinforced Piers

Desk Machine



Dimension

of the Machine



Desk Machine



Internal
Structure
of the Machine

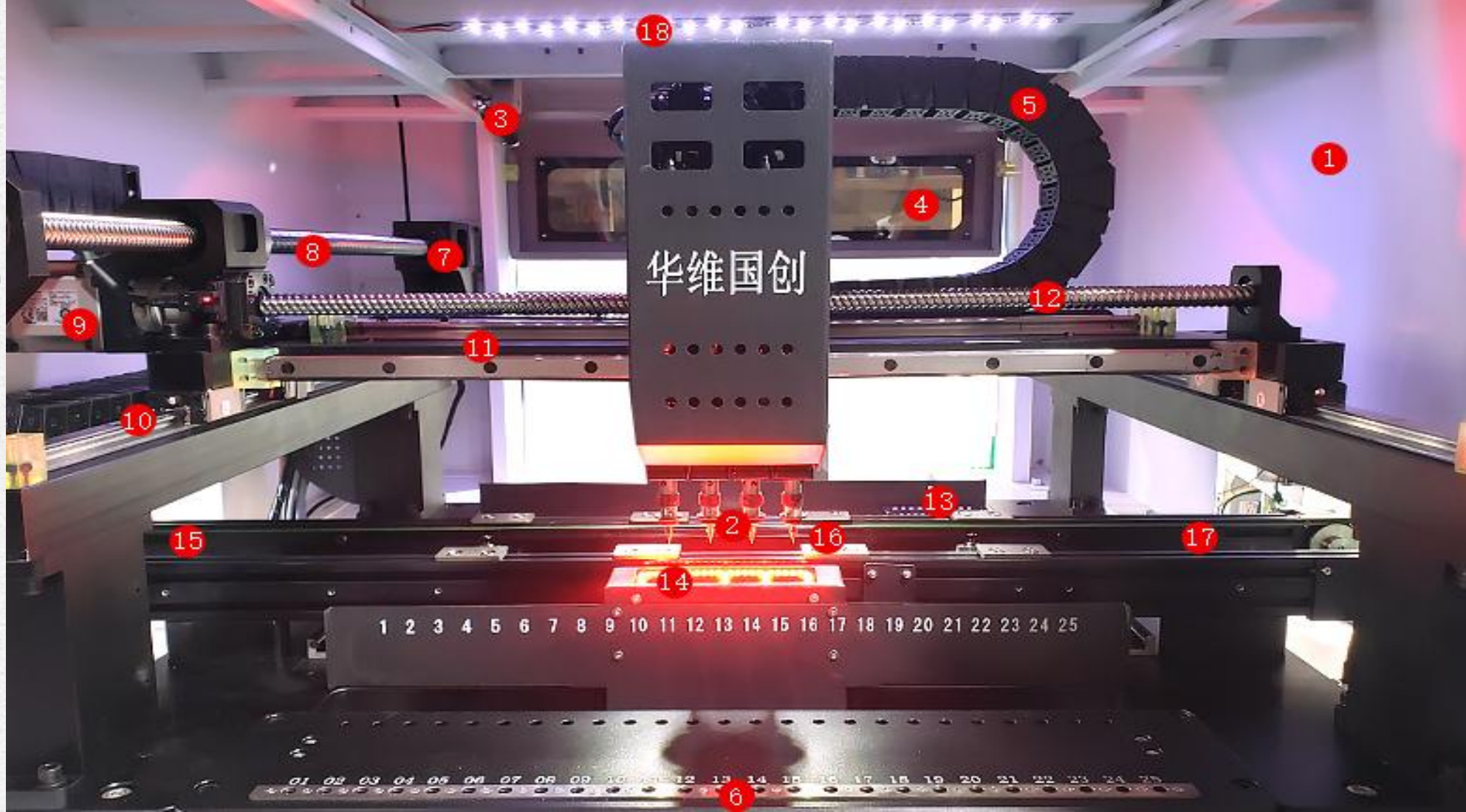

- 1.Housing
- 2.Placement Heads
- 3.Pneumatic Support Bar
- 4.Safety shield
- 5.Flexible Silent Cable Carrier
- 6.Feeder Slots
- 7.Servo Motor of Y Axis
- 8.Ground Ball Screw of Y Axis
- 9.Servo Motor of X Axis
- 10.Linear Motion Guide of Y Axis
- 11.Linear Motion Guide of X Axis
- 12.Ground ball screw of X axis
13. 5MP HD Camera
- 14.1MP Fast HD Camera
- 15.Waiting Area
16. Mounting Area
17. Exiting Area



Mounting Project Optimization System

Path Optimization
Synchronous Picki-
ng

Shortest Path
Majority Priority

Automatic Distri-B
ution of Nozzle S
equence

Global Optimizati-o
n of PCB Path

Friendly Compat-i
bility of Core AI-g
orithms

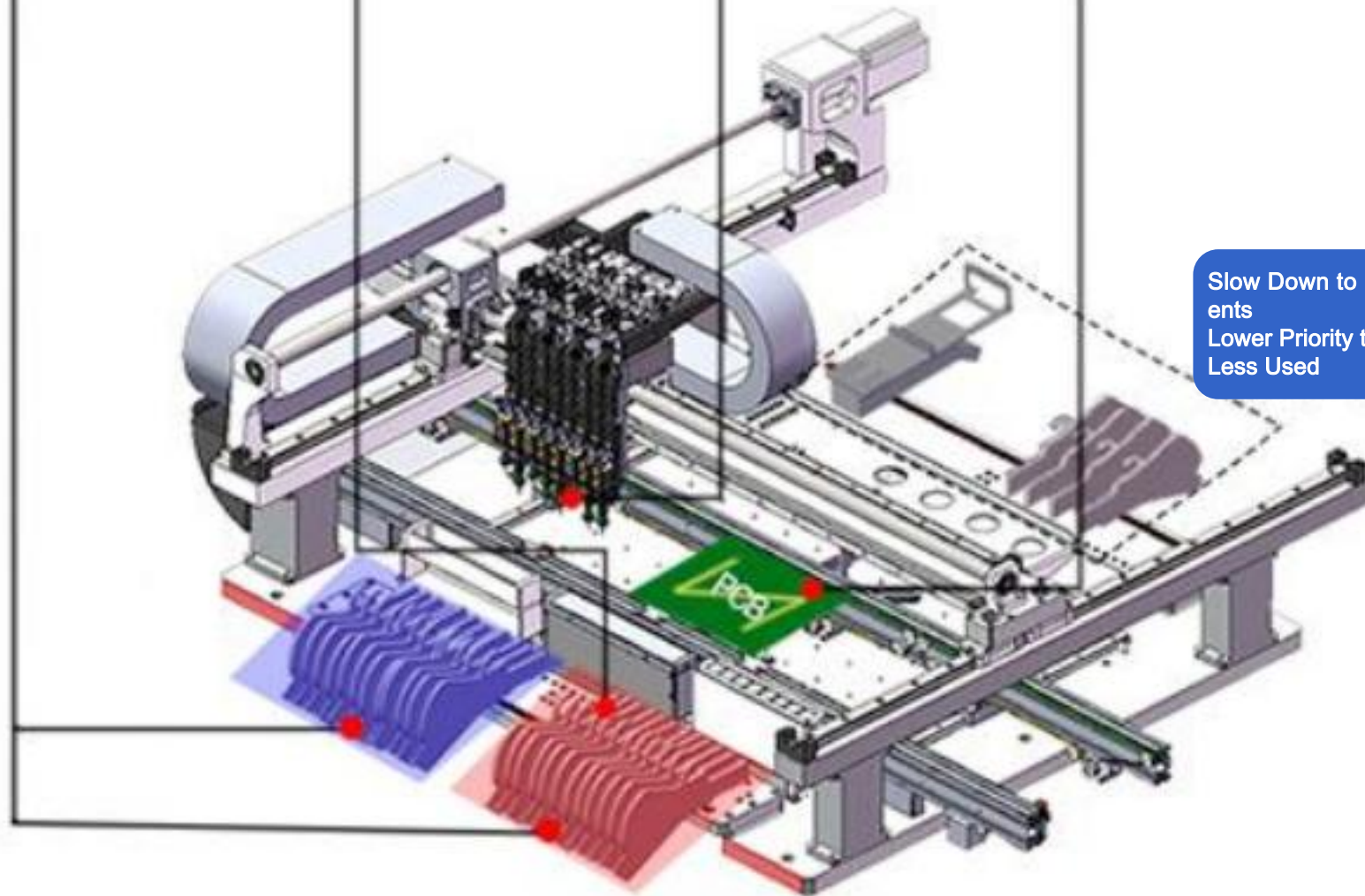

Slow Down to Large Compon-
ents
Lower Priority to Componen-ts
Less Used

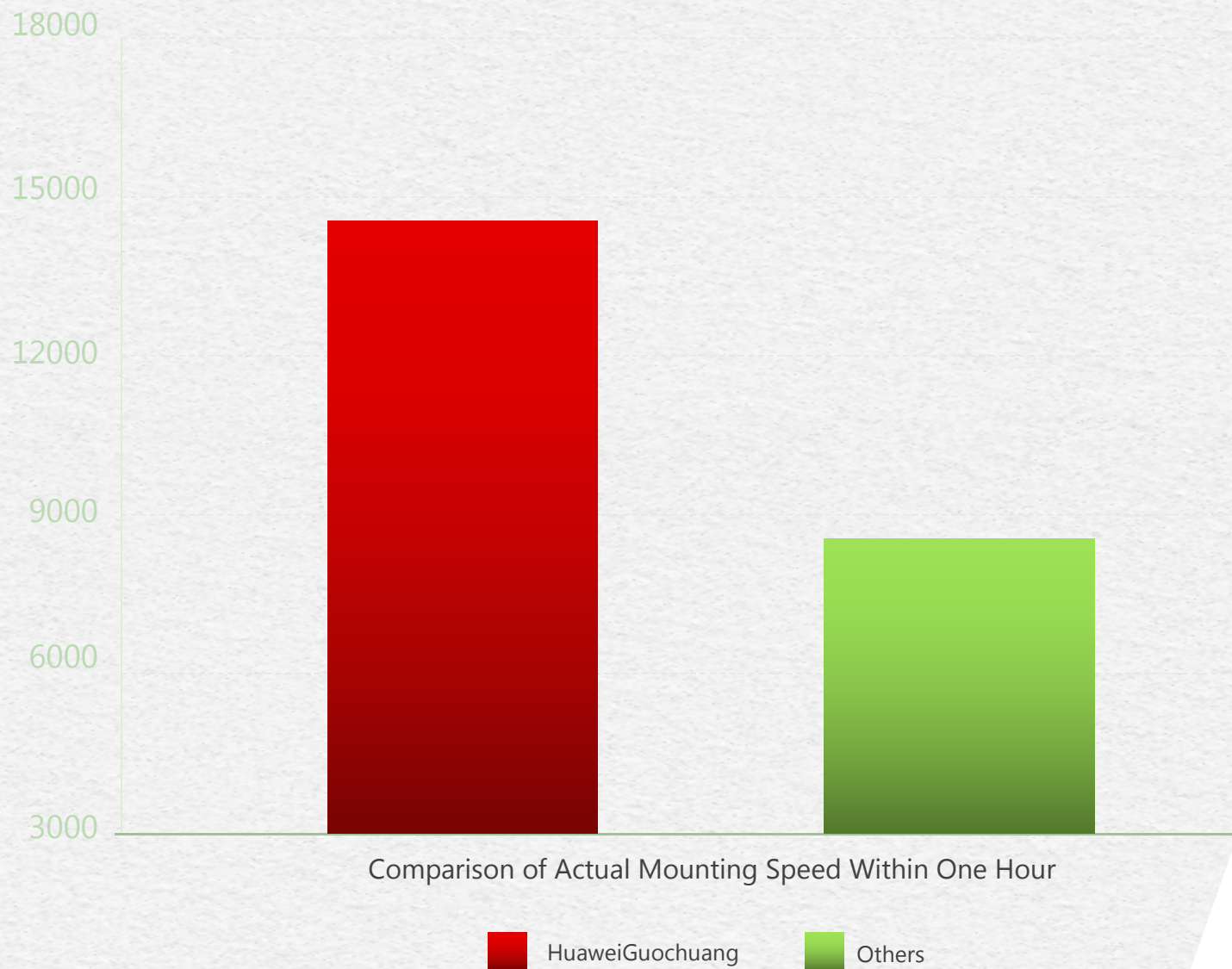

Comparison of Actual Mounting Speed Within One Hour

*The speed is the actual mounting speed calculated by manual hand-held stopwatch within one hour, so as to eliminate the possibility of exaggerating the data with false mark in the software.

Competitive Comparison of Mounting Efficiency



Product Advantages

Software



Intelligent optimization makes the troublesome distribution of multiple components' feeding more efficient and logical, compared with the traditional manual method.

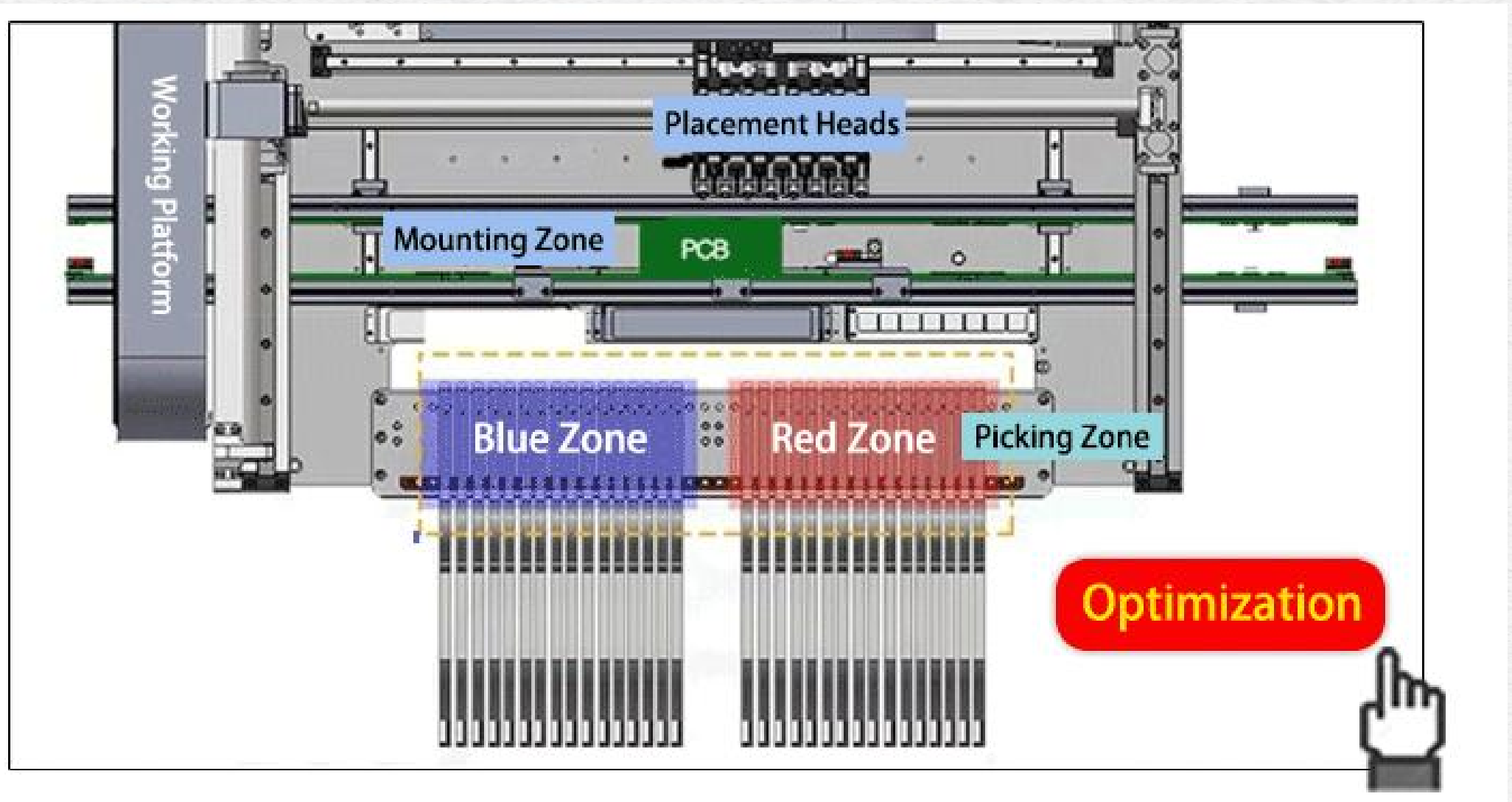

Automatic optimization of feeders' installation positions tackles the problem of tedious manual distribution perfectly

Select nozzle models intelligently according to BOM, and update the position number of corresponding nozzle in the program synchronously.

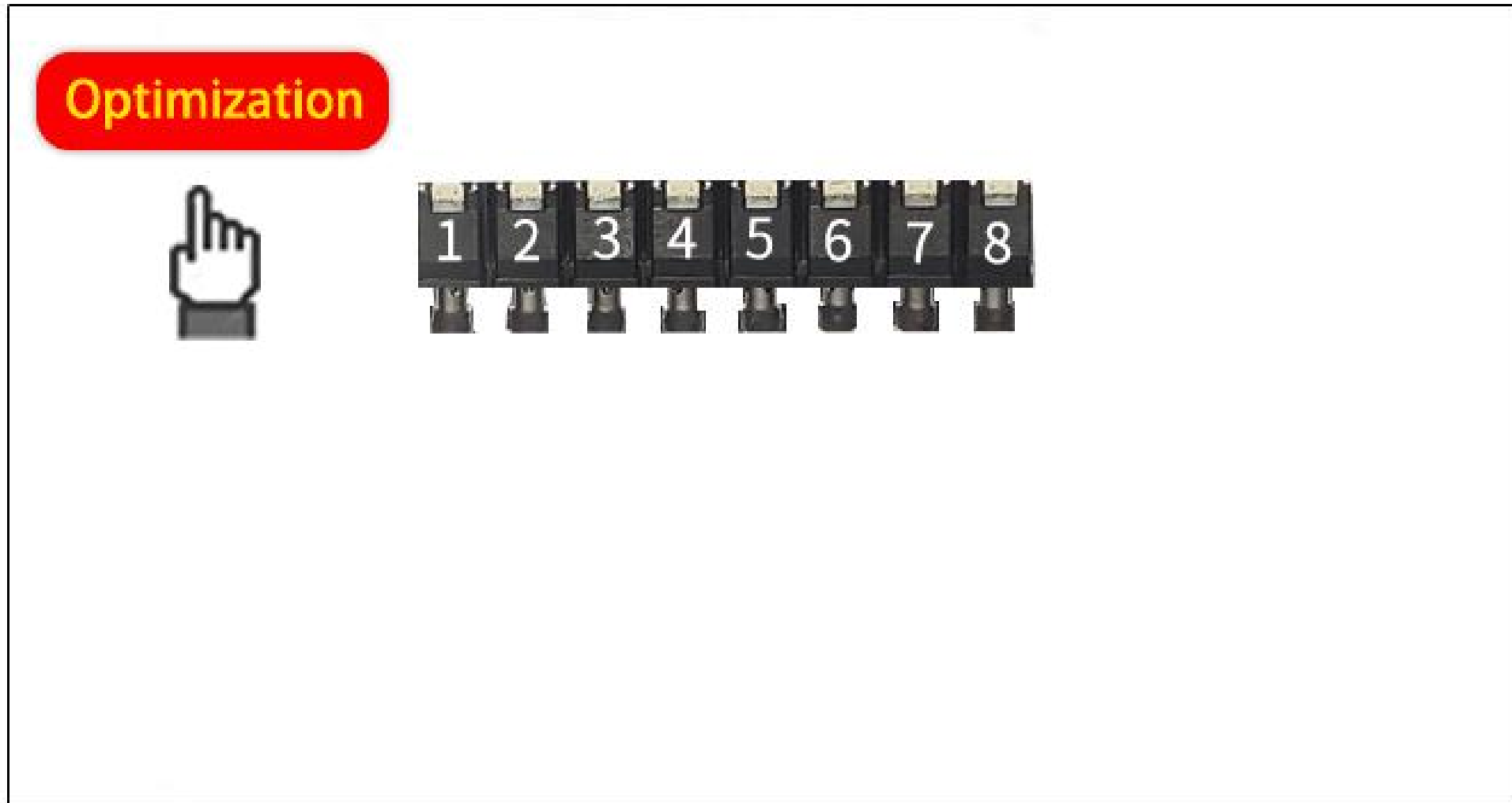

Automatic optimization of nozzles' installation sequence

The seamless connection between feeding and picking is achieved by the one-click optimization implemented by intelligent algorithms.

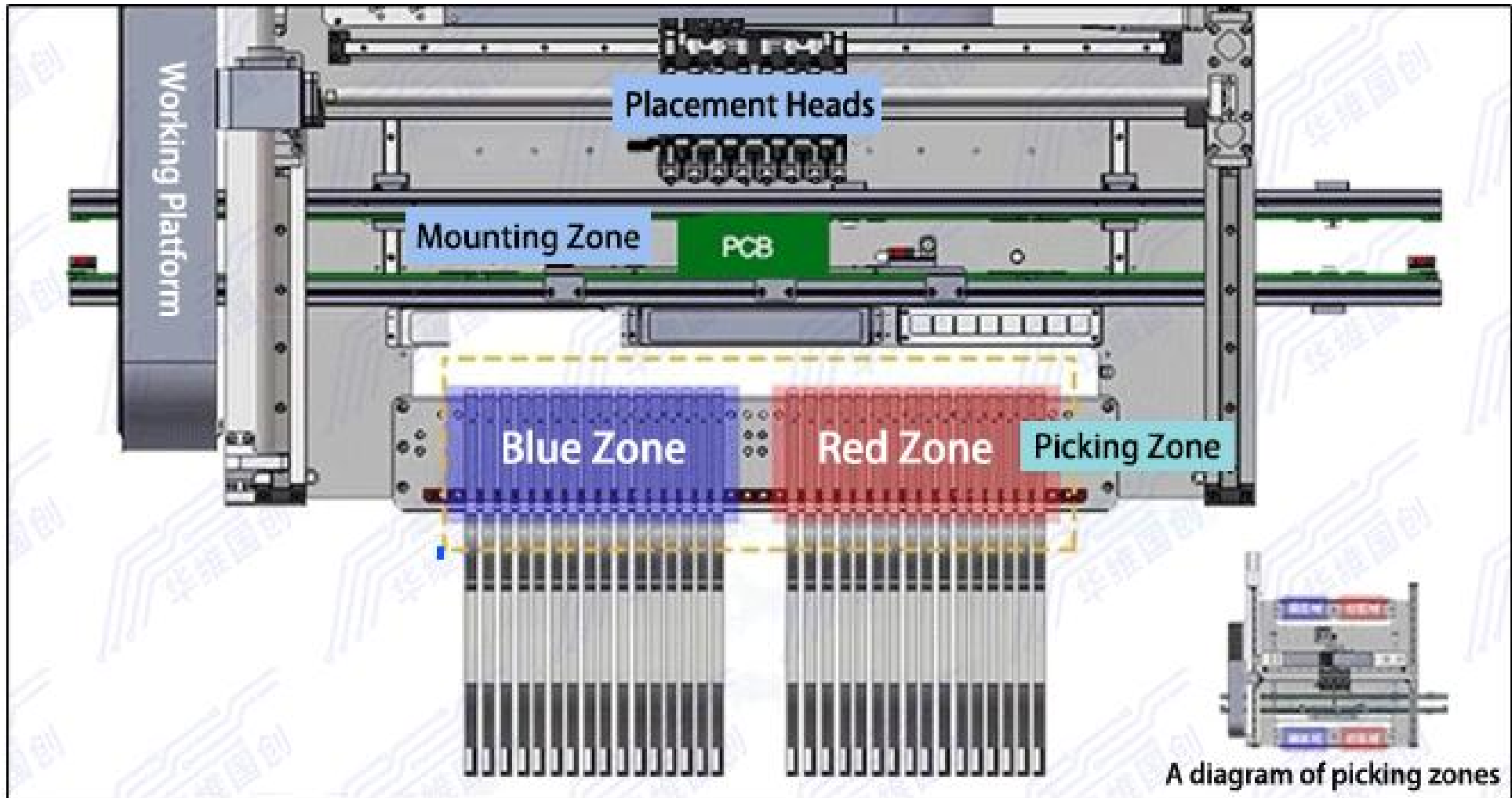

Concurrent picking with multiple heads, which maximize the efficiency of picking

The meaning of this function: It can save 30% programming time costs and greatly improve efficiency by fast, efficient and accurate one-click operation.

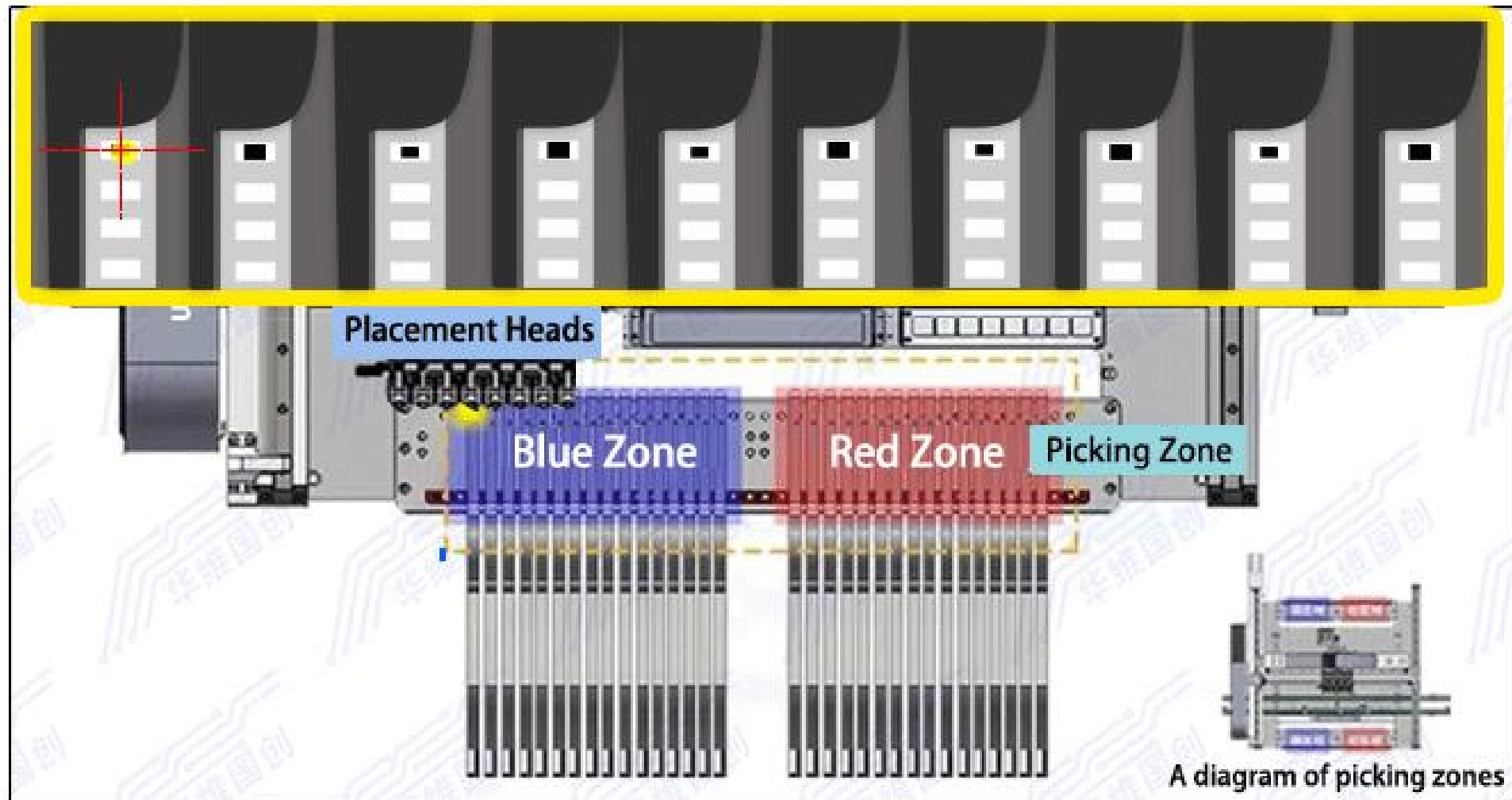

Automatic calibration of feeder picking coordinates

Using the system's intelligent algorithm, HuaweiGuochuang mounting system can help you make it with just one click instead of conducting tests and distributing the complex and massive layout by hand.

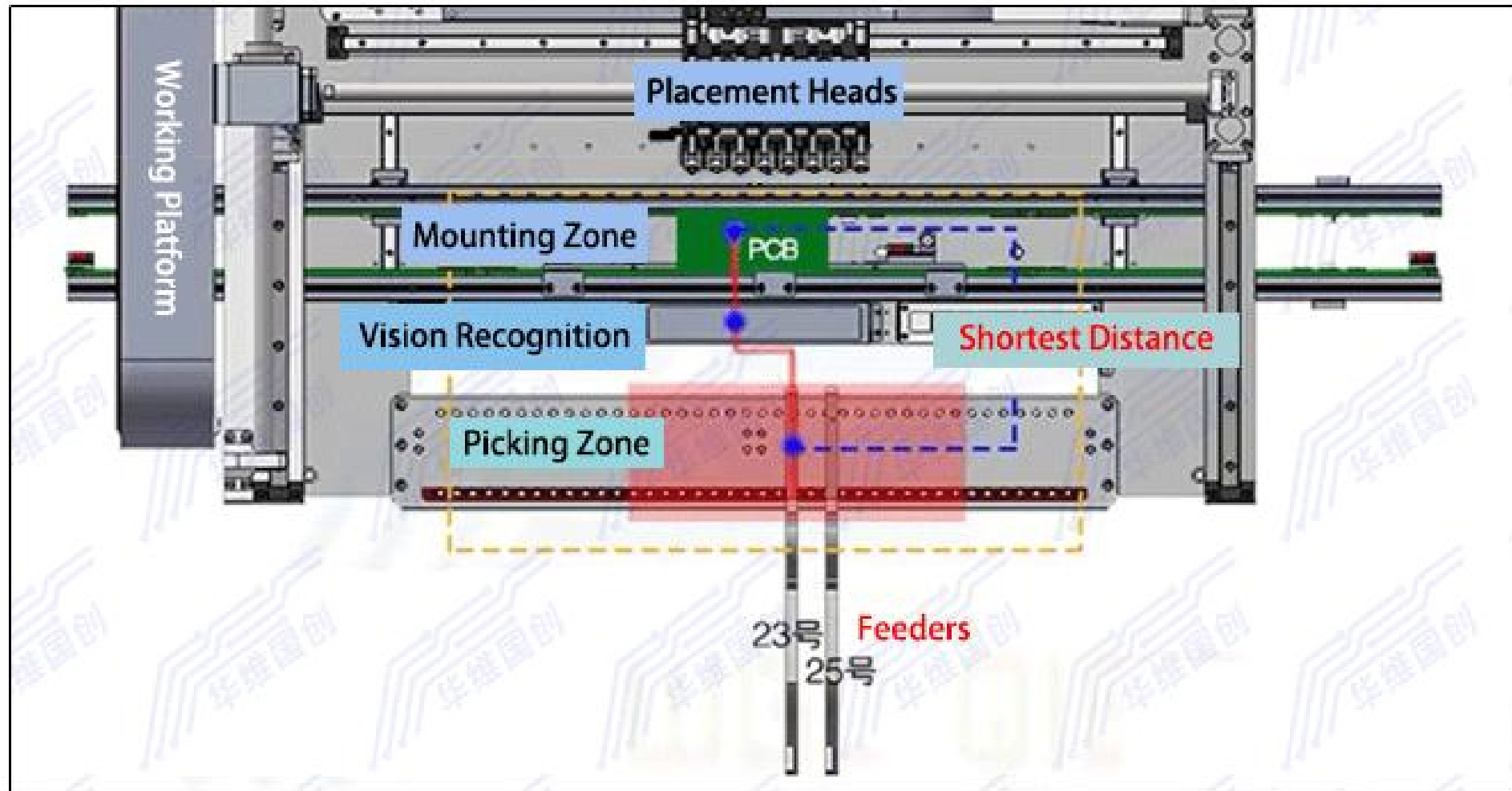

Full automatic layout of the shortest path for mounting

In order to save time costs as much as possible and realize high energy efficiency, we divide the entry process into three stages including waiting stage, mounting stage and exiting stage for finished products.

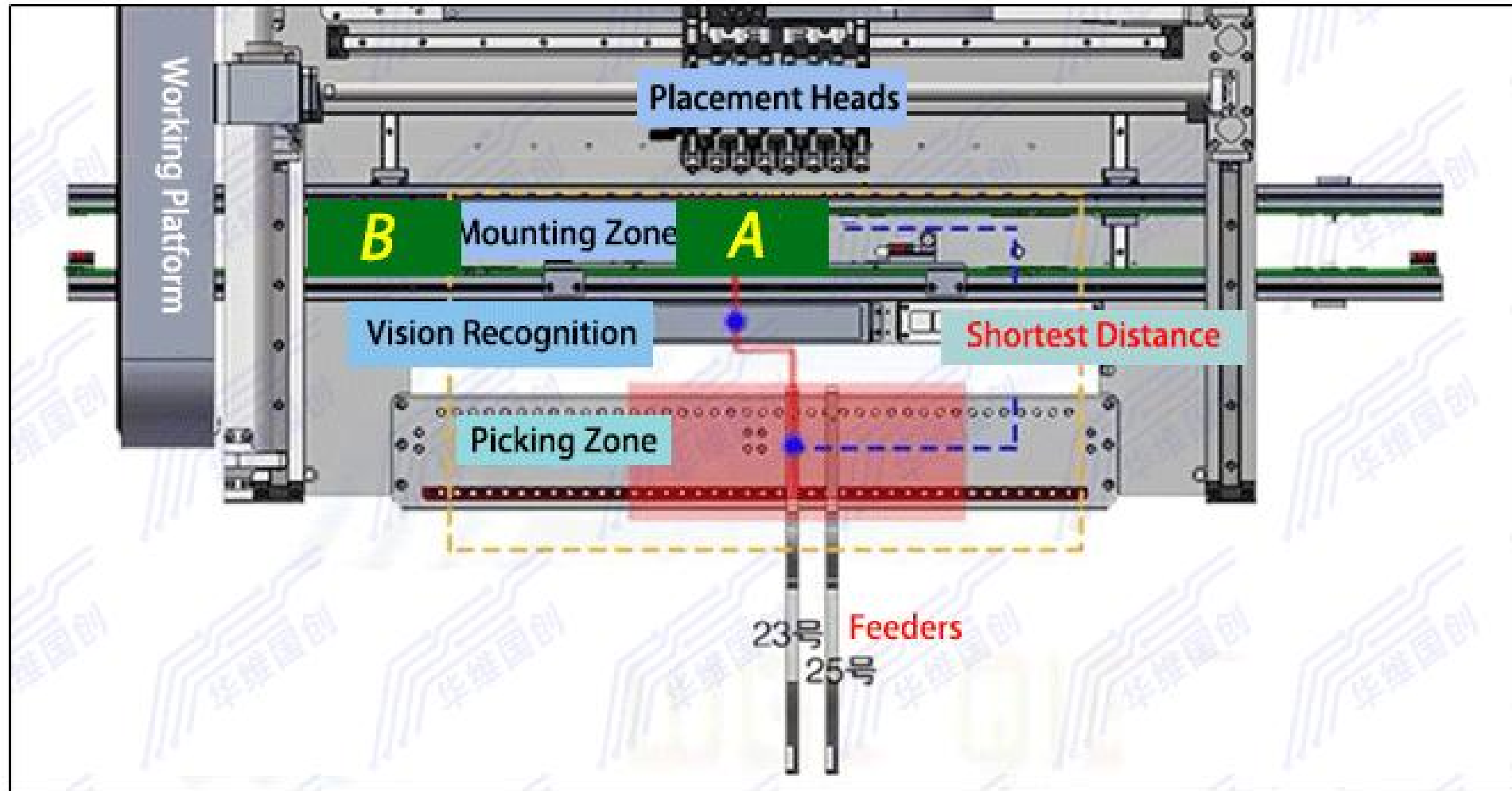

Three-stage entry



Details of Products

True precision, true high-efficiency and true smartness



Industrial Computer

17-inch display, keyboard and mouse.

User-friendly OS already installed, supports WinXP / Win7, vision programming and PCB file importing etc.



Precision Ball Screw and Linear Motion Guide

The use of imported precision ball screw and linear motion guide, will bring long term maintenance-free operation, high accuracy and noise-free running, improves the machine performance effectively.

Guarantee the mounting accuracy of 0201-0402, QFN, QFP and BGA.

Achieve high stability of 24-hour continuous work without downtime, considerably improving the productivity.



High Durable Cable Carrier and Flexible Cable

Use the same type of cable carriers bearing up to 10 million constant motions as imported machines.

Igus flexible cables designed for industrial motion applications, which can resist a range of dangerous conditions, like extreme temperatures and oil, and can handle any type of motion, including horizontal, torsional or high speed, ensure the reliable connection of the electrical circuit in high-speed reciprocating motion.



HD Camera

Professional imported 5MP industrial calibration HD camera used for mounting chips and its supporting 5MP distortion-free industrial vision HD lens.

Four 1MP industrial fast recognition cameras which can increase efficiency significantly by simultaneous recognition of 4 placement heads.

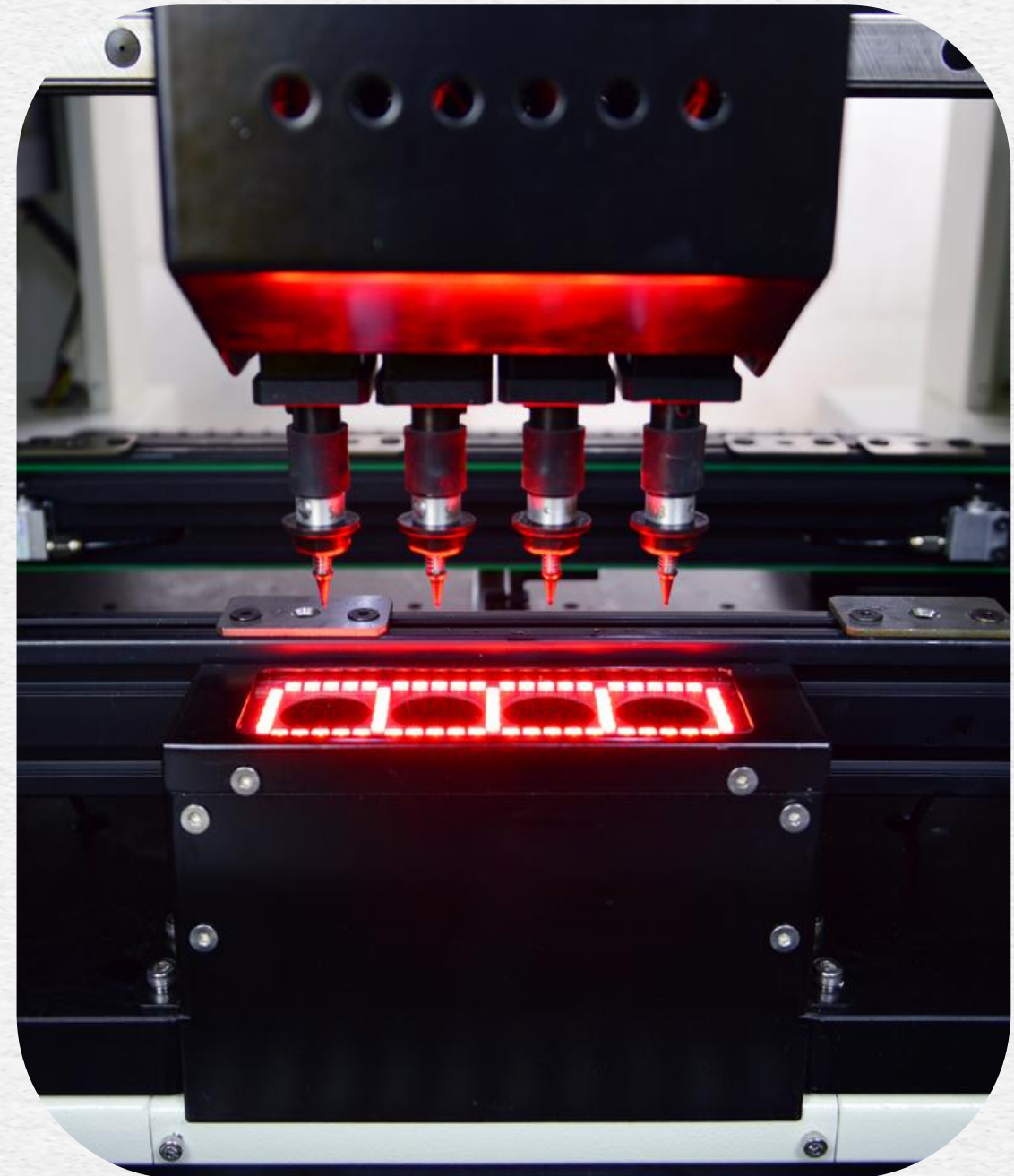



Product Specification

Software part



Model	HW-T4-50F / HW-T4-44FX
Number of Placement Heads	4(high-accuracy)
Number of IC Trays	48
Number of Feeders	50/44(subject to 8mm feeder)
Positioning Accuracy	0.01mm
Repeated Mounting Accuracy	0.02mm
Range of Mounting Speed	7000-8000Pcs/h
Applicable Components	resistor,capacitor,chip,lamp bead etc.
Supported Maximum Area of PCB	(50F)350*190mm /(44FX)350*280mm
Feeders	electric feeder, pneumatic feeder,vibrating feeder, IC tray etc.
Recognition Devices	mark camera x1,fast recognition camera x4, high-precision camera x1
Maximum Height of Applicable Components	≤7mm
PCB Convey Mode	three-stage entry,automatic connection from left to right, automatic PCB positioning
Mark Positioning	manual / automatic
Programming Method	automatic programming after manually importing files of PCB coordinates
Control System	HuaweiGuochuang control system
Maximum Step Length of XY Axis	629mm*679mm
Tracks of XY Axis	double linear motion guide + double ground ball screw
Motion Mode of XY Axis	intelligent linkage of acceleration and deceleration of curve and line, integrated linear interpolation algorithm.

Price	
Control Computer	industrial control computer with Intel high-performance processor
Adjusting Method of Tracks	electric
Range of Nozzle Buffer	4.5mm
Maximum Step Length of Z Axis	20mm
Range of Angle for Components	±180°
Motor	AC Servo Motor
Driver	high-speed DSP driver
Air Supply Requirements	oil water filter, ≥ 50L, dust filter and air pressure stabilizer etc.
Vacuum Supply of Nozzle	Japanese CKD vacuum generator integrating the high-speed vacuum burst function
Range of Air Supply Pressure	0.5-0.6mp
OS	Independent research and development SMT intelligent OS based on Windows
Vision Display	17-inch industrial control display
Cable	German Igus durable flexible cable (10 million times)
Power Supply	220V 50/60Hz
Average Power	600W
Machine Dimensions	desk machine 1140*900*900mm vertical machine 900*1140*1340mm
Weight	(desk machine)210kg (vertical machine)280kg



Software Operation

Reduction of errors caused by manual edit and achievement of intelligent programming



Operating Manual

1

Create production project and set mark points

Import the .CSV file exported from PCB files, generate project coordinates through four corner coordinate positioning, and automatically generate mark points. Through the packaging library, the layout of material station and nozzle can be generated intelligently, and the picking parameters and mounting parameters can be generated at the same time, greatly improving programming speed.

2

Install feeder / nozzle

Install the corresponding feeders of electronic components and nozzles according to the assigned station of the system.

3

Calibrate feeder picking coordinates intelligently

One-click operation without manual work. It can automatically calibrate installed feeder picking coordinates. Originally, it took an hour, but through the function of automatic scanning, it could be completed in a few minutes.

4

Start mounting

After a short manual adjustment and efficient automatic programming, the process quickly enters the first board trial, then you can start mass production if it runs smoothly.



Automatic Assignment of Mark Points

华维国创贴片机智能版控制系统 V2.0 (2020智能版)

MarkCam **FastCam** **HighCam**

Noz 1 **Noz 2** **Noz 3** **Noz 4** **Noz 5** **Noz 6** **Noz 7** **Noz 8**

Mark Para Mark Light Mark Led Fcam Led Hcam Led Zoom x2 Visual Debug Throw

Back Up PCB-fix In-Board

Left Rst Right Rvs Zero Cir PCB-rs Out-Board

Fwrd Down Track- Vacuum On

Track- Vacuum-Off-all

XY Step 10000 Speed 59 Track delay 0.5

Z Step 100 Speed 60 Track speed 8

A Step 78.00 Speed 64

Track Step 64 Speed 56

Rec Cross Circle Scale

	Noz1	Noz2	Noz3	Noz4	Noz5	Noz6	Noz7	Noz8	XY Coord
Height	0	0	0	0	0	0	0	0	X10000
Angle	0.00	0.00	0.00	0.00	0.00	0.00	0.00	0.00	Y10000

DISCONNECT Project Create/Open Project Close DU800_96F.EE Registered System Setting Device Calibration 64

PROJECT: D:\Smt\Customer1\2020_new41黄典盛\RH0120210129.qn

PCB Edit SMT Run PCB Standard Mode Feeder Para

PCB Edit Optimize Feeder Plug Feeder Para Diagnosis SMT Run

PCB Edit

Import PCB Import Coord Import BOM 0/41 Search PCB Check Angle X

n	n	n	n	n	n	n	n	n	n
R17	a0603	3.4							
R20	a0603	21.3							
R3	a0603	29....							
R25	a0603	21....							
R26	a0603	21....							
R27	a0603	21....							
R28	a0603	21....							
R32	a0603	26....							
R10	a0603	1.924							
C5	a0603	18....							
C7	a0603	28....	91....	0	100nF				
C12	a0603	5.3	32.73	90	100nF				
C13	a0603	6.8554	32....	90	100nF				
C14	a0603	8.4	47.3	270	100nF				
C17	a0603	23....	36....	90	100nF				
C20	a0603	22.319	32....	270	100nF				
C23	a0603	18....	32....	90	100nF				
C24	a0603	18	47.3	270	100nF				
C21	a0603	21....	35....	180	100nF				

Label
Chip Value
Footprint
X
Y
Angle
Re-Write
Hidden Current Column
Show All Columns
Optional

Sign in PCB XY (mm) Sign in Machine XY (step) 旋转180放置

Auto Get Sign	Pricise Mode	X	Y	Save	Save
Sign 1	<input checked="" type="checkbox"/>	31.4757	113.698	X50000 Y50000	X50411 Y70245
Sign 2	<input type="checkbox"/>	17.606	2.8071	Sign 1	Sign 3
Sign 3	<input type="checkbox"/>	32.9	43.5	Sign 4	Sign 2
Sign 4	<input type="checkbox"/>	1.7	32.7	X41416 Y73360	X46001 Y81981

PCB

Save goto Save goto

Generate PCB data



Automatic Creation

of Mounting Program After Manually Importing the File of Coordinates

PCB Edit Optimize Feeder Plug Feeder Para Diagnosis SMT Run

PCB Edit

Import PCB Import Coord Import BOM 0/41 Search PCB Check Angle X

	π	π	π	π	π	π	π	π	π	π	π	π
▶	R17	a0603	3.4	32.7	90	100K						
	R20	a0603	21.3	45.2	180	100K						
	R3	a0603	29....	49....	360	100K						
	R25	a0603	21....	38....	180	100K						
	R26	a0603	21....	40....	180	100K						
	R27	a0603	21....	36....	360	100K						
	R28	a0603	21....	41....	360	100K						
	R32	a0603	26....	43....	270	100K						
	R10	a0603	1.9244	46....	90	100K						
	C5	a0603	18....	91....	0	100nF						
	C7	a0603	28....	91....	0	100nF						
	C12	a0603	5.3	32.73	90	100nF						
	C13	a0603	6.8554	32....	90	100nF						
	C14	a0603	8.4	47.3	270	100nF						
	C17	a0603	23....	36....	90	100nF						
	C20	a0603	22.319	32....	270	100nF						
	C23	a0603	18....	32....	90	100nF						
	C24	a0603	18	47.3	270	100nF						
	C21	a0603	21....	35....	180	100nF						

Sign in PCB XY (mm)

Auto Get Sign Pricise Mode

Sign 1	X	31.4757	Y	113.698
Sign 2	X	17.606	Y	2.8071
Sign 3	X	32.9	Y	43.5
Sign 4	X	1.7	Y	32.7

Sign in Machine XY (step) 旋转180放置

X50000
Y50000

Save goto

X50411
Y70245

Save goto

PCB

Sign 1 Sign 3

Sign 4 Sign 2

X41416
Y73360

Save goto

X46001
Y81981

Save goto

Generate PCB data



One-click

Intelligent Optimization of Mounting Program

分类设置 优化生成贴装列表

来自封装库 料槽吸嘴禁用设置 开启备用吸嘴 **一键生成** 本地料站库

删除选定 从其他工程导入料站号 2/2 优化结果

	型号	封装	数量	供料	料站号	多组供料	吸嘴	同取容差(毫米)	相机	视觉算法	识别模式	降速搬运	高度(毫米)
	2	402	48	CL8-4	自动	1	502	0	快速相机	标准视觉	二...	<input type="checkbox"/>	0
▶	5	LQFP1...	1	料盘	自动	1	505	0	高清相机	标准视觉	精...	<input checked="" type="checkbox"/>	0

Automatic Optimization for the Layout of Nozzles and Feeders

Feeder Installation Chart

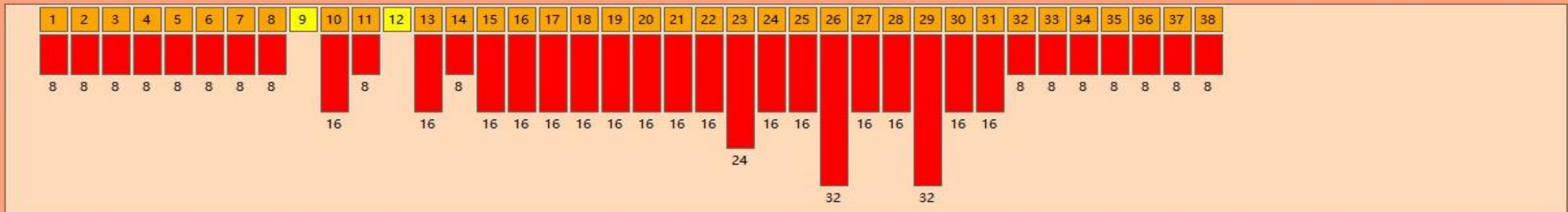
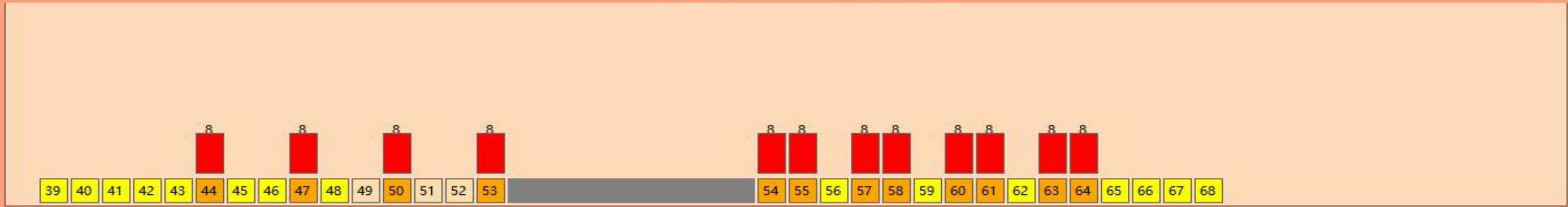

Applicable Components

Resistor and capacitor



Resisto capacitor

Lamp bead



Lamp bead Lamp bead Lamp bead

SOP TO



SOP SOP TO

QFN

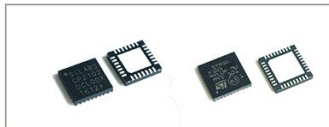

QFN28 QFN36

LQFP



LQFP48 LQFP144

BGA

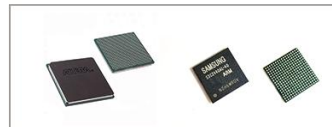

BGA BGA

Pin header connector

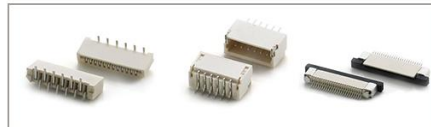

Pin header connector Pin header connector

*0201 , 0402 , 0603 , 0805 , 1206 , diode , triode, SOT and QFP , BGA with lead pitch $\geq 0.3\text{mm}$ (subject to dimension of 40*40 mm and lead center distance 0.5mm) etc.